

PRESSURE PIECE

ADS5010-01 / ADS5010-02 / ADS5010-05

Order no.	▶ Technical data		
	ADS5010-01	ADS5010-02	ADS5010-05
Compatible with installation size	GPD5010	GPD5010	GED5010
Suitable for gripper version	N / S	C / O	GED
Total spring force min. [N]	62.0	62.0	62.0
Total spring force max. [N]	124.0	124.0	124.0
Weight [kg]	0.17	0.18	0.2

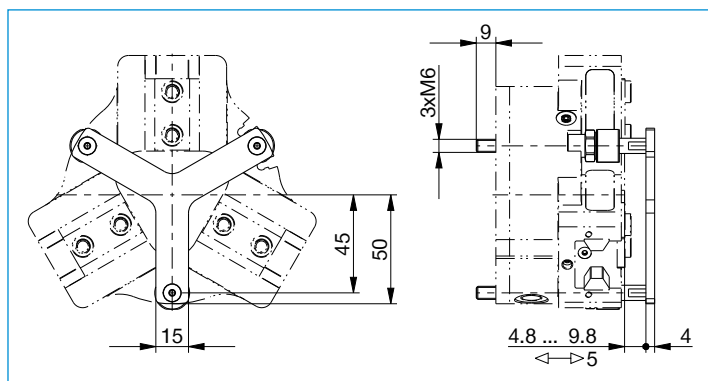

Gripper is fastened via the [pressure piece](#)