

行程调整模块

EB5004 尺寸型号

产品规格



夹持力图表

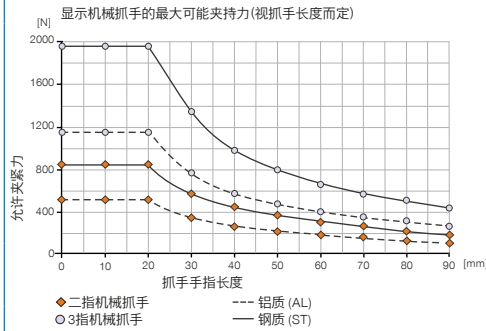

订购编号

适合多种结构尺寸

最大调整范围 [mm]

格栅尺寸 [mm]

每个调整模块的重量 [kg]

技术数据

EB5004AL

GPP5004 / GPD5004

28

7x4

0.06

EB5004ST

GPP5004 / GPD5004

32

8x4

0.13

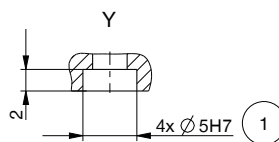
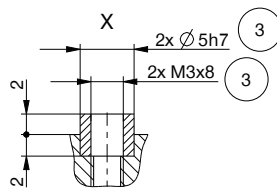
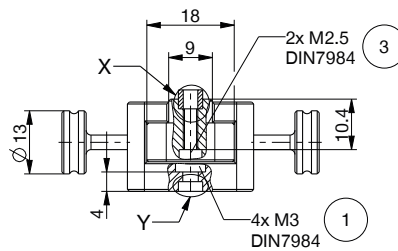
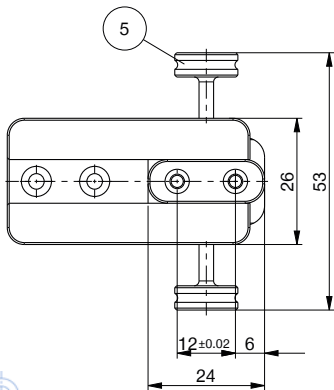
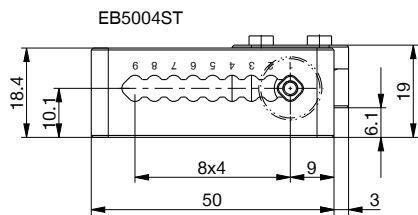
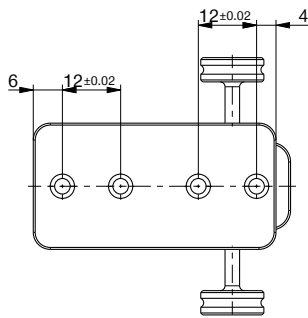

- ① 调整模块固定装置
- ③ 手指固定位置
- ⑤ 调整机构(可拆卸)

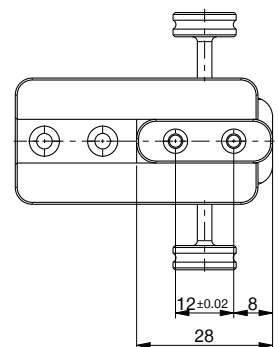
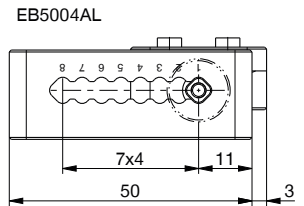

行程调整模块

EB5000 系列

▶ 产品优点



▶ 灵活快速

根据不同工件可方便调整抓手手指行程从而节省时间和成本

▶ 可再生产且结实耐用

格栅编号可帮助您安全设置抓手手指行程位置, FEM 计算得出的调整手指确保您获得最高的过程安全性

▶ 您可将 5000 机械抓手系列中的同一个调整模块安装到相同结构尺寸的不同类型的机械抓手上, 并与其配件结合使用。这有助于提高灵活性, 同时在相同程度上简化您的部件种类, 并因此节约您的库存成本

▶ 面向您具体应用的合适产品



▶ 我们的产品钟爱挑战!

无论哪种极端条件, 无论置身世界何方, 我们久经实践考验的零部件和系统都能实现无尽可能。

欢迎为您的应用挑选合适的产品:

www.zimmer-group.com

▶ 10 秒内即可完成抓手手指行程位置设置



解锁



调整



联锁



* 已旋拧好受压件,为降低干扰轮廓影响可取下

▶ 更多详情请上网查询



所有信息查询请点击:www.zimmer-group.com。产品参数、绘图、3D模型和操作说明均可根据产品型号查询。清晰且实时更新。