

# 3-JAW CONCENTRIC GRIPPERS

## SERIES GD300

### ▶ PRODUCT ADVANTAGES



#### “The economical”

##### ▶ Concentration on the essentials

The most economic type of gripping: This is how you reduce your production costs









##### ▶ Proven T slot guide

This established and proven guiding technology stands for the highest process reliability like no other

##### ▶ Compact structure

Reduces the interference contours for your application

### ▶ SERIES CHARACTERISTICS

Installation size	Version					
GD3XX	N	NC	NO	S	SC	SO
 Spring closing C		•			•	
 Spring opening O			•			•
 High-strength S				•	•	•
 10 million maintenance-free cycles (max.)	•	•	•	•	•	•
 Inductive sensor	•	•	•	•	•	•
 Magnetic field sensor	•	•	•	•	•	•
 Purged air	•	•	•	•	•	•
 IP 40	•	•	•	•	•	•



## ► BENEFITS IN DETAIL



- ① **Robust, lightweight housing**  
- Hard-coated aluminum alloy
- ② **Energy supply**  
- possible from several sides
- ③ **Mounting and positioning**  
- mounting possible from several sides for versatile positioning
- ④ **Gripper jaw**  
- individual gripper finger mounting
- ⑤ **Wedge hook mechanism**  
- synchronized the movement of the gripper jaws  
- high force transfer
- ⑥ **Integrated gripping force safety device**  
- spring integrated into cylinder as energy storage
- ⑦ **Position sensing**  
- permanent magnet for direct monitoring of piston movement
- ⑧ **Integrated, adjustable switch cam**  
- for direct position sensing of the gripper jaw
- ⑨ **Mounting block**  
- mounting for inductive proximity switch (10)

## ► TECHNICAL DATA

Installation size	Stroke per jaw [mm]	Gripping force [N]	Weight [kg]	IP class
GD303	3	200 - 300	0,13 - 0,16	IP40
GD304	2 - 4	450 - 1500	0,22 - 0,28	IP40
GD306	3 - 6	750 - 2300	0,5 - 0,65	IP40
GD308	4 - 8	1200 - 4000	0,85 - 1,2	IP40
GD310	5 - 10	2000 - 6400	1,6 - 2,2	IP40
GD312	6 - 12	3500 - 9250	2,7 - 3,8	IP40
GD316	8 - 16	6500 - 19100	5,1 - 8	IP40
GD320	10 - 20	8200 - 18700	9,6	IP40
GD330	15 - 30	15300 - 34700	24	IP40

## ► FURTHER INFORMATION IS AVAILABLE ONLINE



All information just a click away at: [www.zimmer-group.com](http://www.zimmer-group.com). Find data, illustrations, 3D models and operating instructions for your installation size using the order number for your desired product. Quick, clear and always up-to-date.

# 3-JAW CONCENTRIC GRIPPERS

## INSTALLATION SIZE GD310

### ▶ PRODUCT SPECIFICATIONS



#### ▶ Gripping force diagram

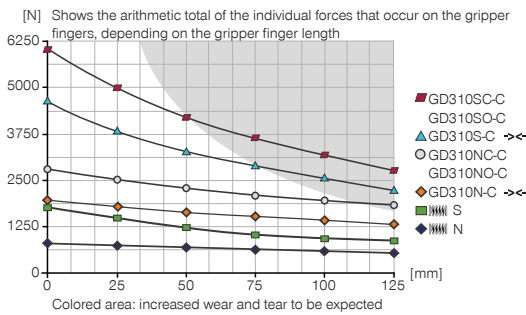

#### ▶ Forces and moments

Displays static forces and moments that can also have an effect, besides the gripping force.

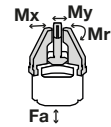

Mr [Nm]	75
Mx [Nm]	100
My [Nm]	90
Fa [N]	2500

### ▶ INCLUDED IN DELIVERY



6 [piece]  
Centering Disc  
DST41000

### ▶ RECOMMENDED ACCESSORIES



#### GRIPPING COMPONENTS



**UB310**  
Universal jaw set aluminium



**UB310ST**  
Universal jaw set steel



**ADS310N-S**  
Pressure piece N / S



**ADS310C-O**  
Pressure piece NC / NO / SC / SO



#### ENERGY SUPPLY



**GV1-8X8**  
Straight Fittings - Quick Connect Style



**WV1-8X8**  
Angled Fittings - Quick Connect Style



#### ENERGY SUPPLY



**DSV1-8**  
Pressure safety valve



**DSV1-8E**  
Pressure safety valve with quick exhaust



#### SENSORS



**NJ8-E2S**  
Inductive proximity switch - Connector M8



**MFS01-S-KHC-P1-PNP**  
Magnetic field sensor angled, cable 0.3 m - M8 connector



**MFS02-S-KHC-P1-PNP**  
Magnetic field sensor straight, cable 0.3 m - M8 connector



**MFS02-S-KHC-IL**  
Position sensor straight, cable 0.3 m - connector M8

Order no.	▶ Technical data					
	GD310N-C	GD310NC-C	GD310NO-C	GD310S-C	GD310SC-C	GD310SO-C
Stroke per jaw [mm]	10	10	10	5	5	5
Gripping force in closing [N]	2000	2800		4400	6200	
Gripping force in opening [N]	2100		2900	4600		6400
Gripping force secured by spring min. [N]		800	800		1800	1800
Closing time [s]	0.1	0.07	0.2	0.1	0.07	0.2
Opening time [s]	0.1	0.2	0.07	0.1	0.2	0.07
Repetition accuracy +/- [mm]	0.05	0.05	0.05	0.05	0.05	0.05
Operating pressure min. [bar]	2	4	4	2	4	4
Operating pressure max. [bar]	8	8	8	8	8	8
Nominal operating pressure [bar]	6	6	6	6	6	6
Operating temperature min. [°C]	+5	+5	+5	+5	+5	+5
Operating temperature max. [°C]	+80	+80	+80	+80	+80	+80
Air volume per cycle [cm <sup>3</sup> ]	100	220	220	100	220	220
Protection to IEC 60529	IP40	IP40	IP40	IP40	IP40	IP40
Weight [kg]	1.6	2.1	2.1	1.6	2.2	2.1

NC / NO / SC / SO

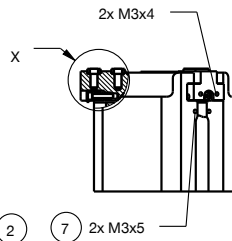
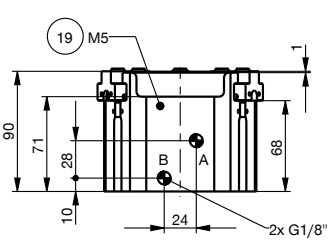
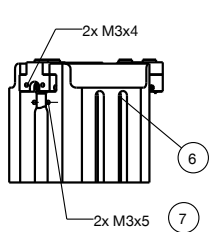
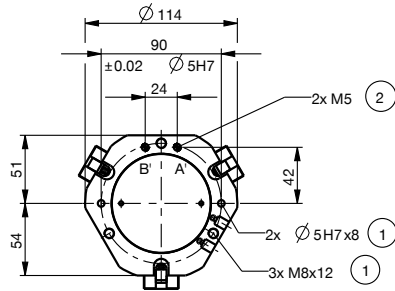

- ① Gripper attachment
- ② Energy supply
- ③ Fixing for gripper finger
- ⑥ Integrated slot for magnetic field sensor
- ⑦ Fixing for mounting block
- ⑰ Air purge connection option
- ⑳ Adapter
- ㉑ Gripper
- Ⓐ Air connection (close)
- Ⓑ Air connection (open)
- Ⓐ Air connection, alternative (close)
- Ⓑ Air connection, alternative (open)

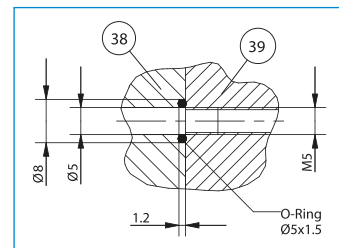

Hoseless air feed-through

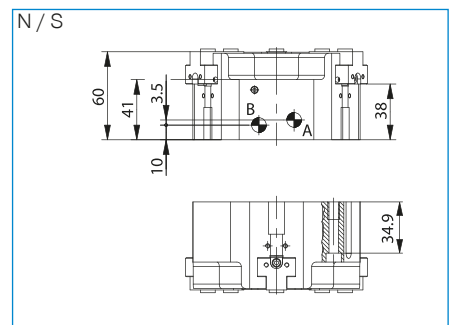
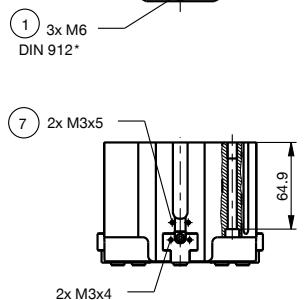
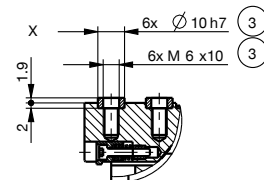
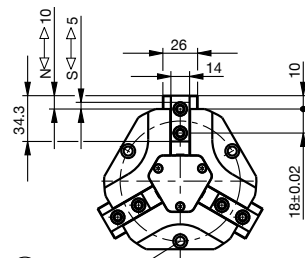

# 3-JAW CONCENTRIC GRIPPERS

## SERIES GD300 FUNCTIONAL DESCRIPTION



### GRIPPING COMPONENTS

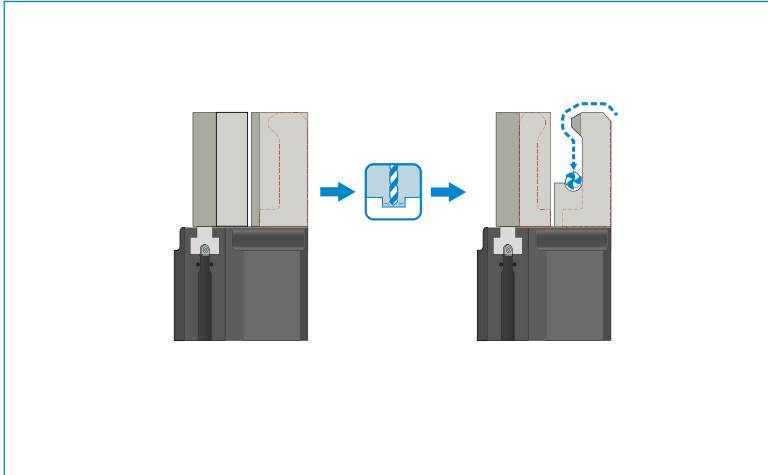

#### Universal jaws – UB300

When the gripper fingers are open, the pressure piece is used for spring-supported positioning of the workpiece against a limit stop. This greatly reduces the loads on the gripper that arise during joining.



#### Pressure piece – ADS300

When the gripper fingers are open, the pressure piece is used for spring-supported positioning of the workpiece against a limit stop. This greatly reduces the loads on the gripper that arise during joining.



## ENERGY SUPPLY

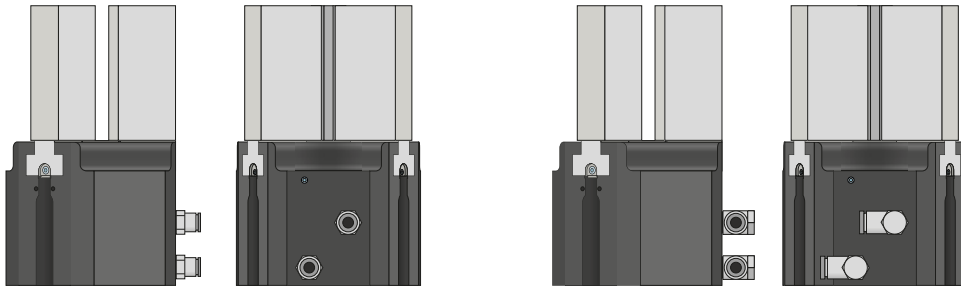

### Pneumatic threaded connections

Available in straight and angled design. Can be chosen freely depending on the space conditions or installation situation.

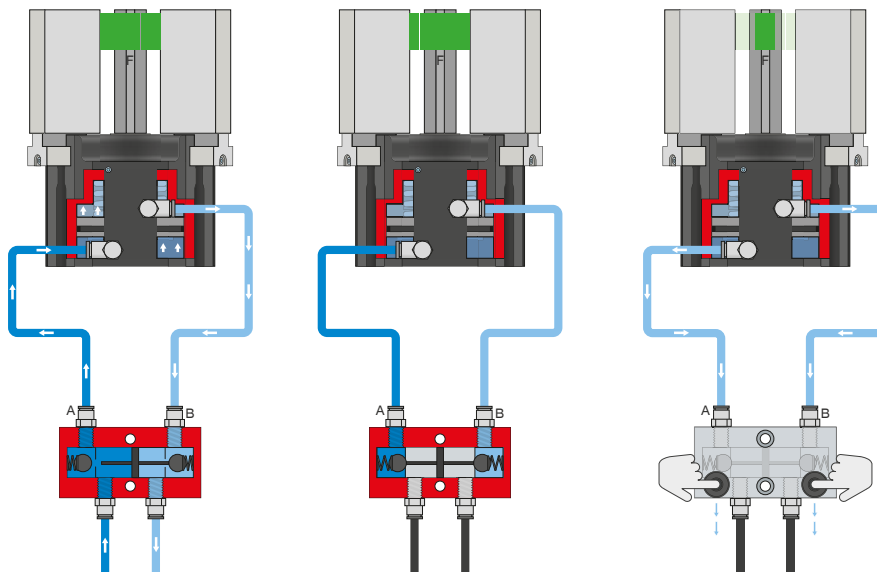

### Pressure safety valve – DSV

Ensures safe retention of force and position if the system pressure drops

The integrated double check valve, which can be unlocked, retains the system pressure of the gripper in case of EMERGENCY STOP. To ensure the function, the valve must be installed as close to the gripper's air connection as possible. In variant E, two pushbuttons are installed that allow for controlled bleeding of the gripper.

# 3-JAW CONCENTRIC GRIPPERS

## SERIES GD300 FUNCTIONAL DESCRIPTION



### SENSORS



#### Inductive sensors – NJ

The sensor is inserted into the mounting block as far as it will go and secured. Tuning to the desired position then takes place by adjusting the cam switch. The sensors are available in versions with 5 m cables with exposed leads and 0,3 m cable with connector, as well as with direct plug orientation.



## SENSORS

MFS02

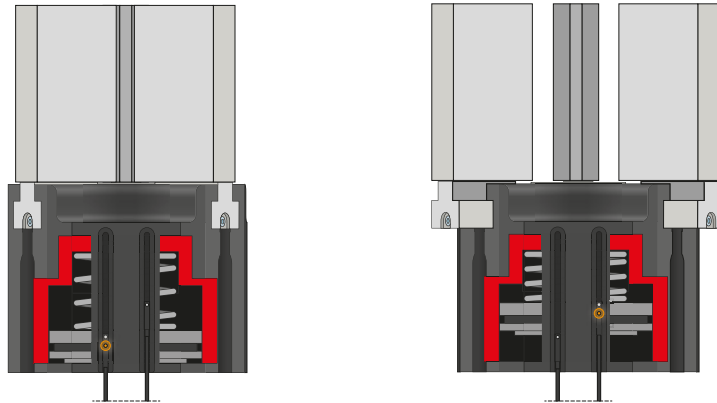

MFS01

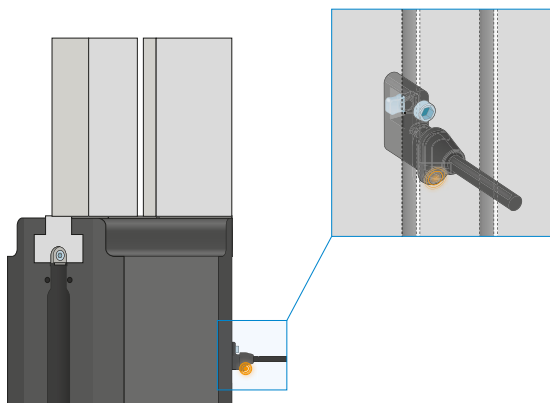

### 1-point magnetic field sensors – MFS

#### For non-contact sensing of the piston position

These sensors are installed in the C-groove of the gripper and detect the magnet attached to the piston of the gripper. To ensure use in a wide variety of space conditions, the sensors are available in two variants. While the horizontal MFS02, with straight cable outlet, disappears into the C-groove of the gripper almost completely, the vertical MFS01 is taller, but has a cable outlet that is offset at an angle of 90°. The variants are available in versions with 5 m cables with exposed leads and 0,3 m cable with connector.



# 3-JAW CONCENTRIC GRIPPERS

## SERIES GD300 FUNCTIONAL DESCRIPTION



### CONNECTIONS / OTHER



#### Plug-in connectors

##### For extending and fabricating the connection lines

Cables with a length of 10 m with exposed leads are available. Depending on the specific needs, the cables can be shortened or fabricated with connectors in sizes M12. A 5 m long cable with connector / socket is available for the IO-Link connection.

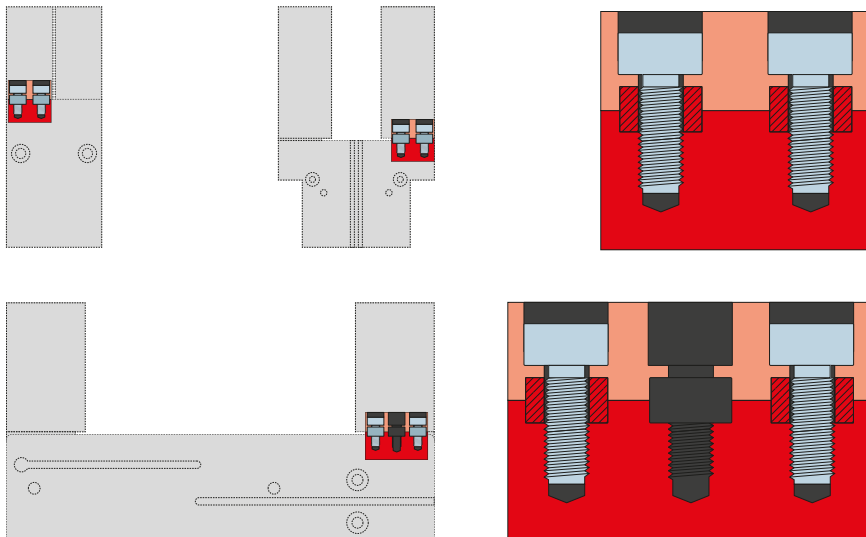

#### Centering sleeves

##### For defined position measurement of the gripper fingers

The centering sleeves are inserted into the fits of the gripper jaws to define the position of the gripper fingers. The centering sleeves are comparable to a pin connection.