

# 2指张角式抓手

## GG4000 系列

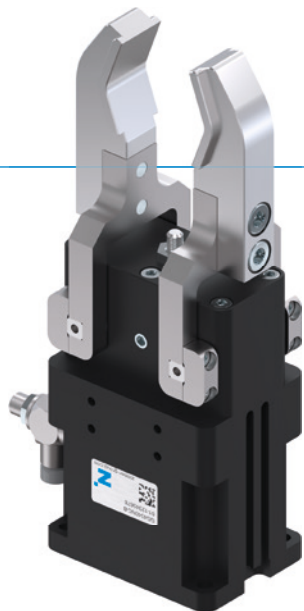







### ▶ 产品优点



#### "密封的"

- ▶ **适合在极恶劣的环境下使用**  
密封的旋转轴确保在恶劣环境下使用的可靠性
- ▶ **灵活的行程调整**  
您可以根据您应用需要使用调节螺丝调节其180°的张开角度
- ▶ **无间断的持续工作**  
“德国制造”象征着我们决不妥协的质量要求, 保证免维护运行一千万次循环

### ▶ 产品特点

尺寸型号	版本	
GG40XX-B	NC	SC
 弹簧式自锁/常闭	●	●
 高夹持力		●
 (最多)1千万次循环免维护	●	●
 接近传感器	●	●
 磁场传感器	●	●
 耐腐蚀	●	●
 阻隔空气密封	●	●
 IP64	●	●



## 优势细节

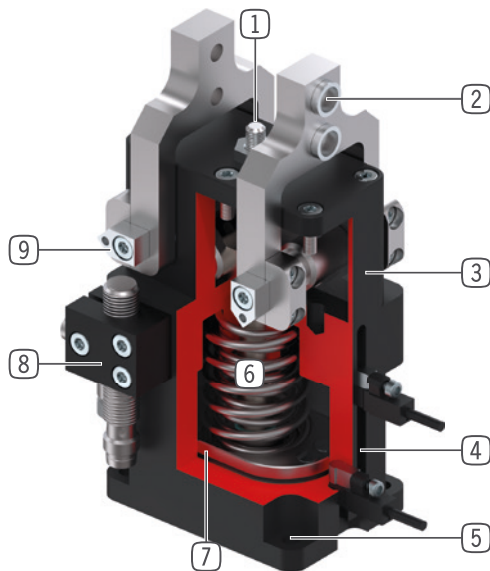

- ① 行程调节螺丝  
- 可调节张开角度
- ② 可拆卸中心定位环  
- 独立手指安装
- ③ 坚固且轻的外壳  
- 硬涂层铝合金
- ④ 检测槽  
- 用于安装磁性传感器
- ⑤ 安装和定位  
- 多个不同的安装面可方便安装
- ⑥ 内置保持力安全装置  
- 气缸内置弹簧作为能量储存
- ⑦ 位置检测  
- 永久磁铁直接检测活塞运动
- ⑧ 安装块  
- 安装接近开关
- ⑨ 密封的旋转关节  
- 适用于恶劣环境下

## 技术数据

尺寸型号	单边行程(+/-) [°]	夹持力 [N]	重量 [kg]	IP 等级
GG4032	20 - 90	430 - 460	0,25	IP64
GG4040	20 - 90	700 - 800	0,5	IP64
GG4049	20 - 90	1000 - 1150	0,85	IP64
GG4058	20 - 90	1650 - 1900	1,4	IP64
GG4072	20 - 90	1950 - 2700	2,45	IP64
GG4084	20 - 90	3500 - 4000	4,5	IP64

## 更多详情请上网查询



所有信息查询请点击:[www.zimmer-group.com](http://www.zimmer-group.com)。产品参数、绘图、3D模型和操作说明均可根据产品型号查询。清晰且实时更新。

# 2指张角式抓手

## GG4084 尺寸型号

### 产品规格

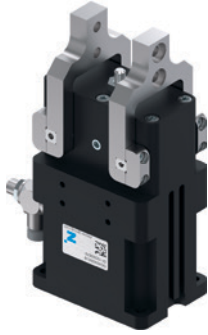

#### 夹持力图表

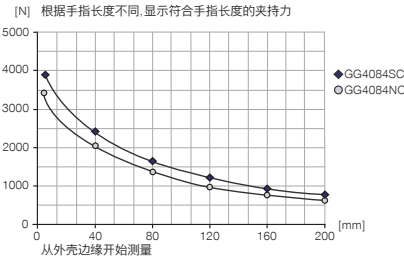

#### 力和力矩

显示除夹持力外可能作用的静力和力矩。

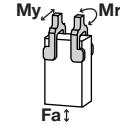

Mr [Nm]	60
My [Nm]	60
Fa [N]	1800

#### 转动惯量

GG4084NC-B

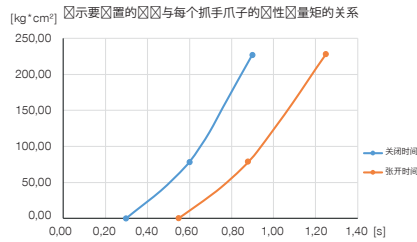

#### 转动惯量

GG4084SC-B

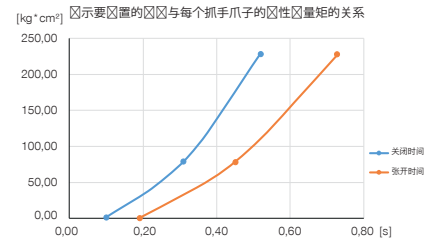

### 随货提供



1 [个]  
中心定位环  
DST43000



2 [个]  
流量控制阀 - 转动式  
DRV1-8X8

### 配件建议



#### 能源供应



DSV1-8E  
带快速排气装置的压力安全阀



#### 传感器



MFS02-S-KHC-P1-PNP  
磁场传感器直的, 电缆0.3m-插头M8



#### 传感器



KB8-49  
接近开关安装座



MFS01-S-KHC-P2-PNP  
2点传感器盖, 电缆0.3 m-插头M8



NJ8-E2S  
接近开关 - M8连接头



MFS02-S-KHC-P2-PNP  
2点传感器直头, 电缆0.3 m-连接器M8



MFS02-S-KHC-IL  
直式位置传感器, 电缆 0.3 米 - 插头 M8



MFS01-S-KHC-P1-PNP  
倾斜的磁场传感器, 电缆0.3 m-插头M8



订购编号	▶ 技术数据	
	GG4084NC-B	GG4084SC-B
单边行程 [°]	90	20
在0°闭合抓取力矩 [Nm]	135	156
弹簧确保的最小力矩 [Nm]	35	50
抓斗关闭时的抓取力为0° [N]	3500	4000
已安装的抓手手指的自最大重 [kg]	1	1
最大抓手手指长度 [mm]	175	175
闭合时间 [s]	0.27	0.11
张开时间 [s]	0.48	0.25
重复定位精度 +/- [mm]	0.05	0.05
最小操作气压 [bar]	4	4
最大操作气压 [bar]	8	8
额定操作气压 [bar]	6	6
最低操作温度 [°C]	5	5
最高操作温度 [°C]	+80	+80
每循环耗气体积 [cm³]	220	170
根据IEC 60529标准安全保护	IP64	IP64
重量 [kg]	4.7	4.7

