

# 2-JAW PARALLEL GRIPPERS

## SERIES GP400

### ▶ PRODUCT ADVANTAGES



#### “The economical”

##### ▶ Concentration on the essentials

The most economic type of gripping: This is how you reduce your production costs









##### ▶ Proven T slot guide

This established and proven guiding technology stands for the highest process reliability like no other

##### ▶ Compact structure

Reduces the interference contours for your application

### ▶ SERIES CHARACTERISTICS

Installation size	Version					
GP4XX	N	NC	NO	S	SC	SO
 Spring closing C		•			•	
 Spring opening O			•			•
 High-strength S				•	•	•
 10 million maintenance-free cycles (max.)	•	•	•	•	•	•
 Inductive sensor	•	•	•	•	•	•
 Magnetic field sensor	•	•	•	•	•	•
 Purged air	•	•	•	•	•	•
 IP 40	•	•	•	•	•	•



## ► BENEFITS IN DETAIL



- ① **Robust, lightweight housing**  
- Hard-coated aluminum alloy
- ② **Mounting and positioning**  
- mounting possible from several sides for versatile positioning
- ③ **Energy supply**  
- possible from several sides
- ④ **Gripper jaw**  
- individual gripper finger mounting
- ⑤ **Sensing slot**  
- mounting and positioning of magnetic field sensors
- ⑥ **Wedge hook mechanism**  
- synchronized the movement of the gripper jaws
- ⑦ **Integrated gripping force safety device**  
- spring integrated into cylinder as energy storage
- ⑧ **Position sensing**  
- permanent magnet for direct monitoring of piston movement
- ⑨ **Mounting block**  
- mounting for inductive proximity switch (10)

## ► TECHNICAL DATA

Installation size	Stroke per jaw [mm]	Gripping force [N]	Weight [kg]	IP class
GP403	3	85 - 115	0,08 - 0,1	IP40
GP404	2 - 4	170 - 500	0,14 - 0,16	IP40
GP406	3 - 6	300 - 950	0,27 - 0,32	IP40
GP408	4 - 8	550 - 1660	0,5 - 0,57	IP40
GP410	5 - 10	740 - 2340	0,85 - 1	IP40
GP412	6 - 12	1290 - 4130	1,5 - 1,78	IP40
GP416	8 - 16	1860 - 5780	2,9 - 3,4	IP40
GP420	10 - 20	3175 - 9400	5,5 - 6,7	IP40
GP430	15 - 30	6675 - 19275	14 - 18,9	IP40

## ► FURTHER INFORMATION IS AVAILABLE ONLINE



All information just a click away at: [www.zimmer-group.com](http://www.zimmer-group.com). Find data, illustrations, 3D models and operating instructions for your installation size using the order number for your desired product. Quick, clear and always up-to-date.

# 2-JAW PARALLEL GRIPPERS

## INSTALLATION SIZE GP430

### ▶ PRODUCT SPECIFICATIONS

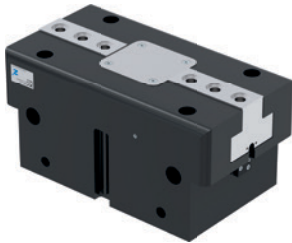

#### ▶ Gripping force diagram

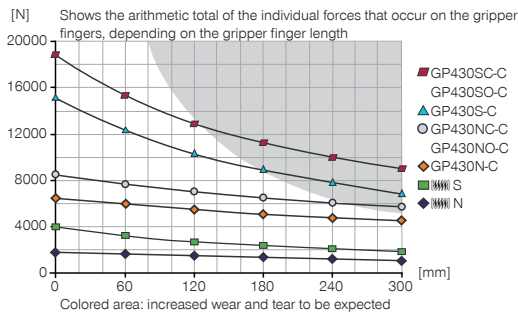

#### ▶ Forces and moments

Displays static forces and moments that can also have an effect, besides the gripping force.



Mr [Nm]	200
Mx [Nm]	275
My [Nm]	300
Fa [N]	9000

### ▶ INCLUDED IN DELIVERY



2 [piece]  
Mounting block  
KB8K



4 [piece]  
Centering Disc  
DST43000

### ▶ RECOMMENDED ACCESSORIES



#### GRIPPING COMPONENTS



**UB430**  
Universal jaw set aluminium



**UB430ST**  
Universal jaw set steel



#### ENERGY SUPPLY



**GV1-4X8**  
Straight Fittings - Quick Connect Style



**DSV1-8E**  
Pressure safety valve with quick exhaust



#### SENSORS



**NJ8-E2S**  
Inductive proximity switch - Connector M8



**MFS01-S-KHC-P1-PNP**  
Magnetic field sensor angled, cable 0.3 m - M8 connector



#### SENSORS



**MFS02-S-KHC-P1-PNP**  
Magnetic field sensor straight, cable 0.3 m - M8 connector



**MFS01-S-KHC-P2-PNP**  
2-point sensor angled, cable 0.3 m - M8 connector



**MFS02-S-KHC-P2-PNP**  
2-point sensor straight, cable 0.3 m - M8 connector



**MFS02-S-KHC-IL**  
Position sensor straight, cable 0.3 m - connector M8



#### CONNECTIONS / OTHER



**KAG500**  
Plug-in connector Straight Cable 5m - Socket M8 (female)



**S8-G-3**  
Plug-in connector customizable Straight - Connector M8

Order no.	► Technical data					
	GP430N-C	GP430NC-C	GP430NO-C	GP430S-C	GP430SC-C	GP430SO-C
Stroke per jaw [mm]	30	30	30	15	15	15
Gripping force in closing [N]	6675	8480		14900	18930	
Gripping force in opening [N]	6830		8640	15250		19275
Gripping force secured by spring min. [N]		1800	1800		4030	4030
Closing time [s]	0.4	0.4	0.8	0.4	0.4	0.8
Opening time [s]	0.4	0.8	0.4	0.4	0.8	0.4
Repetition accuracy +/- [mm]	0.01	0.01	0.01	0.01	0.01	0.01
Operating pressure min. [bar]	3	4	4	3	4	4
Operating pressure max. [bar]	8	8	8	8	8	8
Nominal operating pressure [bar]	6	6	6	6	6	6
Max. operating pressure for sealing air [bar]	0.5	0.5	0.5	0.5	0.5	0.5
Operating temperature min. [°C]	+5	+5	+5	+5	+5	+5
Operating temperature max. [°C]	+80	+80	+80	+80	+80	+80
Air volume per cycle [cm <sup>3</sup> ]	980	1850	1850	980	1850	1850
Protection to IEC 60529	IP40	IP40	IP40	IP40	IP40	IP40
Weight [kg]	13	17	17	13	17	17

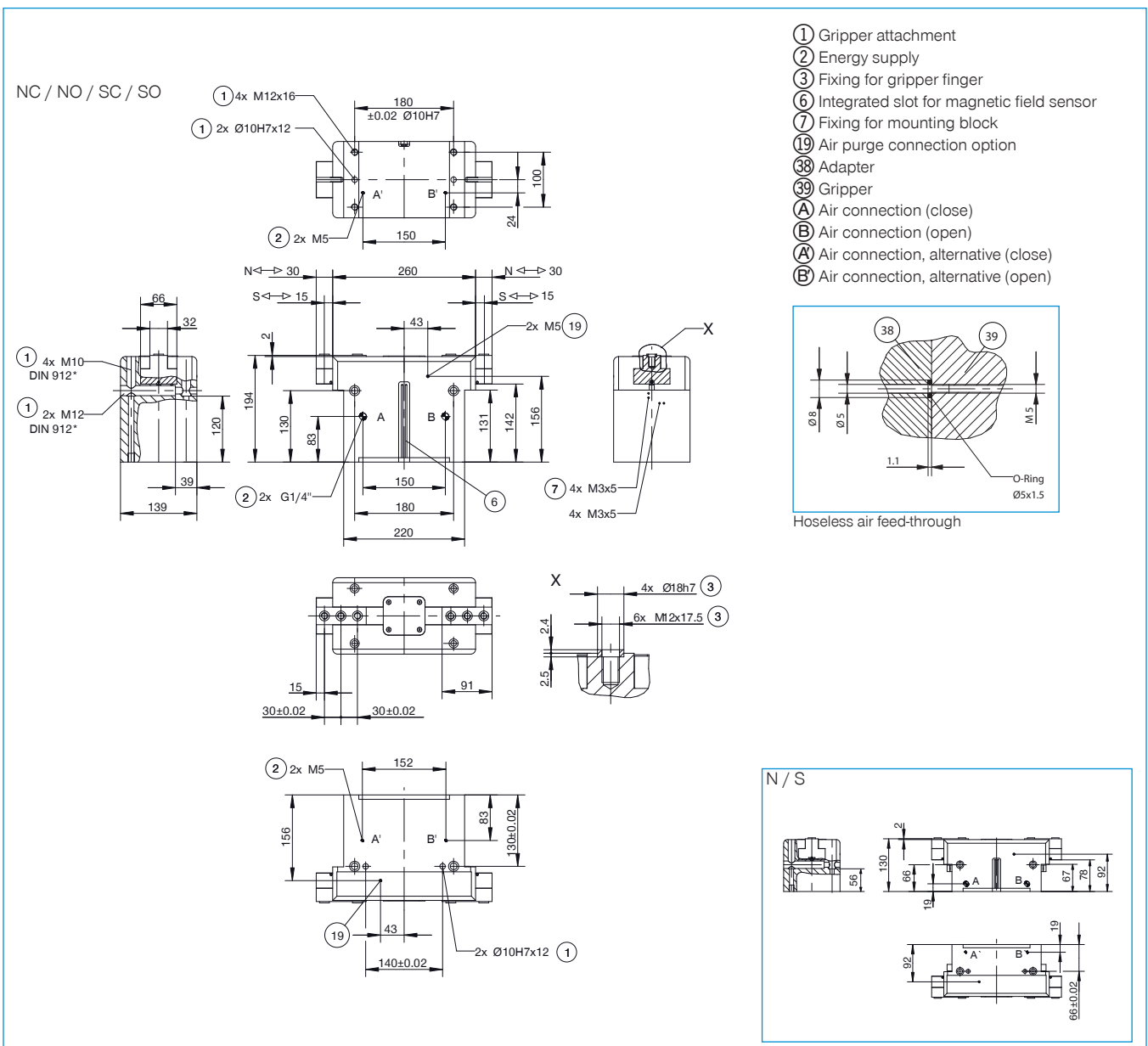

# 2-JAW PARALLEL GRIPPERS

## SERIES GP400 FUNCTIONAL DESCRIPTION



### GRIPPING COMPONENTS

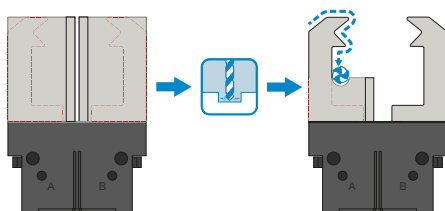

#### Universal jaws – UB400

Can be used immediately or for individual reprocessing

The gripper blanks are available in an aluminum (AL) and also in a steel (ST) version and are installed directly on the gripper using the screws in the scope of delivery. The fits for the centering sleeves are already in place for this purpose. One universal jaw set is required for each gripper.



### ENERGY SUPPLY

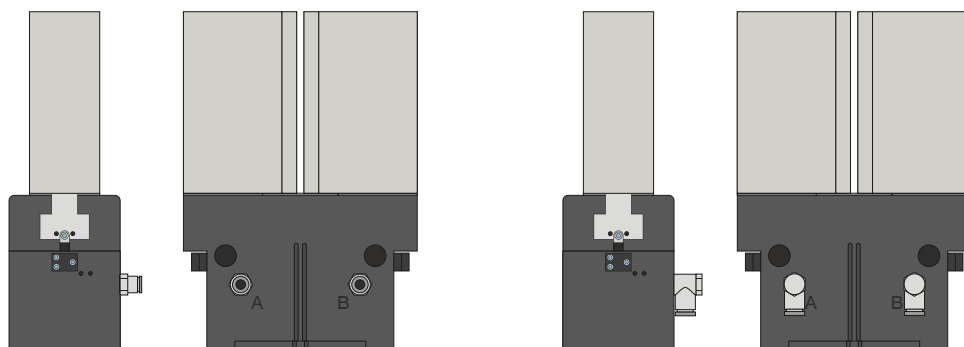

#### Pneumatic threaded connections

Available in straight and angled design. Can be chosen freely depending on the space conditions or installation situation.



## ENERGY SUPPLY

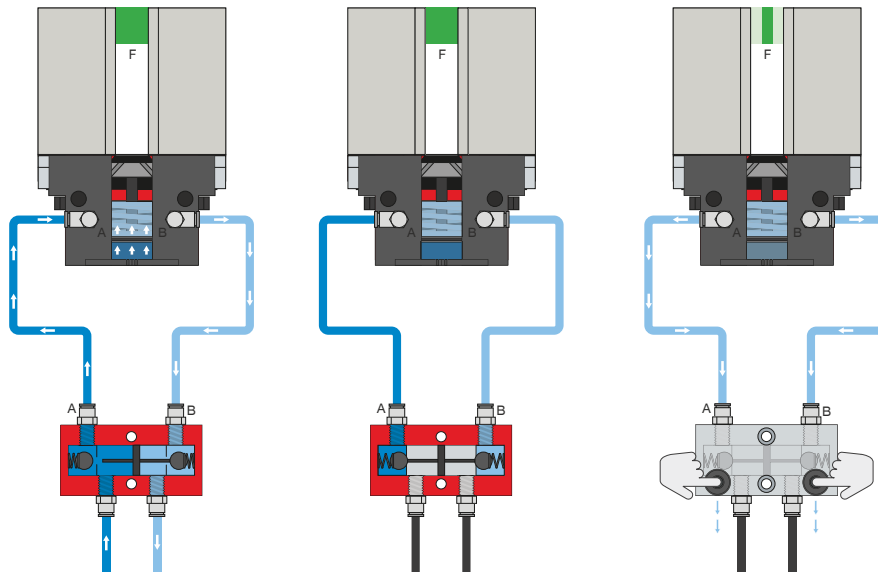

### Pressure safety valve – DSV

Ensures safe retention of force and position if the system pressure drops

The integrated double check valve, which can be unlocked, retains the system pressure of the gripper in case of EMERGENCY STOP. To ensure the function, the valve must be installed as close to the gripper's air connection as possible. In variant E, two pushbuttons are installed that allow for controlled bleeding of the gripper.

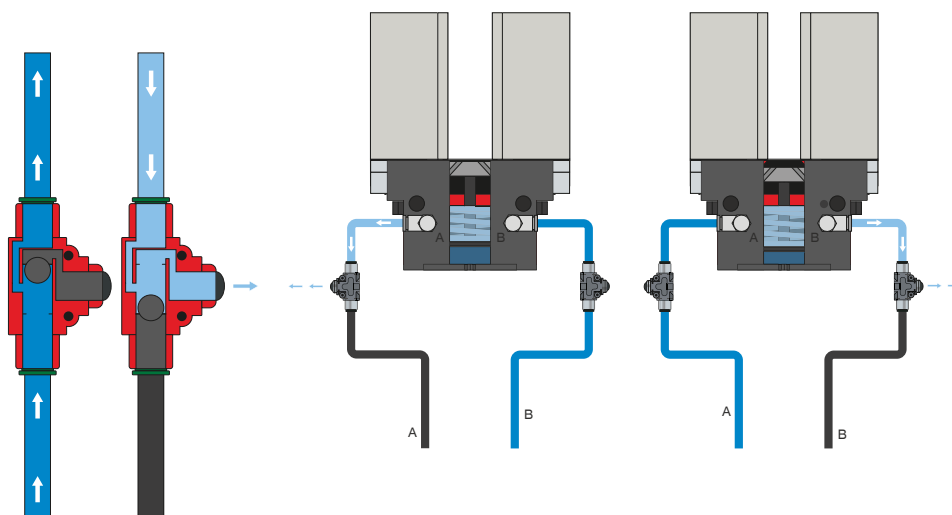

### Quick exhaust valve – DEV

For rapid bleeding of the compressed air and preventing back pressure

The inline valves make a faster cycle time possible and prevent the formation of condensate in grippers with a small cylinder volume. To ensure the function, the valve must be installed as close to the gripper's air connection as possible.

# 2-JAW PARALLEL GRIPPERS

## SERIES GP400 FUNCTIONAL DESCRIPTION



### SENSORS

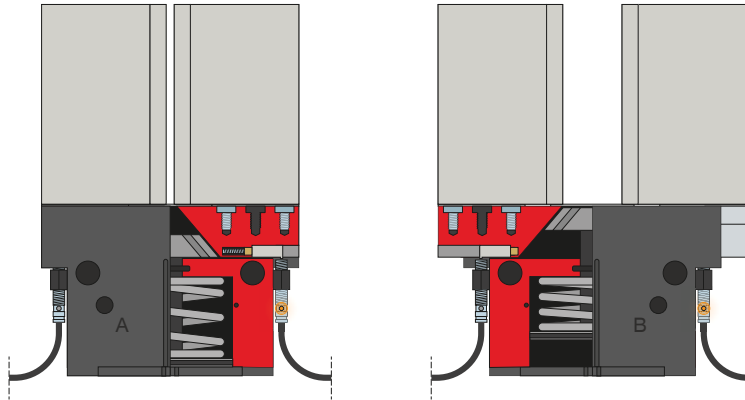

#### Inductive sensors – NJ

The sensor is inserted into the mounting block as far as it will go and secured. Tuning to the desired position then takes place by adjusting the cam switch. The sensors are available in versions with 5 m cables with exposed leads and 0,3 m cable with connector, as well as with direct plug orientation.



## SENSORS

### MFS02

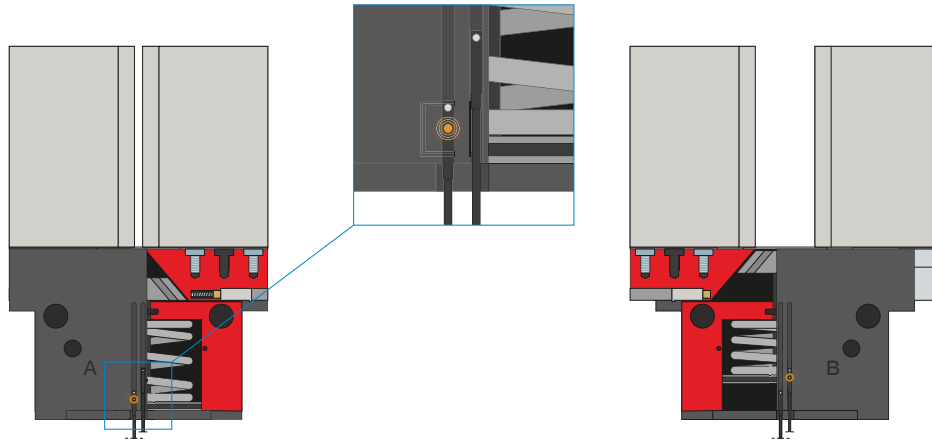

### MFS01

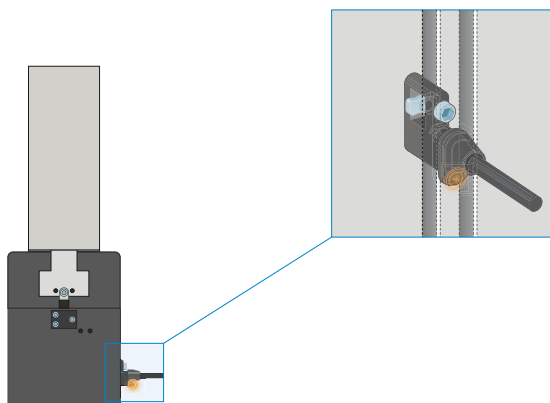

### 1-point magnetic field sensors – MFS

#### For non-contact sensing of the piston position

These sensors are installed in the C-groove of the gripper and detect the magnet attached to the piston of the gripper. To ensure use in a wide variety of space conditions, the sensors are available in two variants. While the horizontal MFS02, with straight cable outlet, disappears into the C-groove of the gripper almost completely, the vertical MFS01 is taller, but has a cable outlet that is offset at an angle of 90°. The variants are available in versions with 5 m cables with exposed leads and 0,3 m cable with connector.



# 2-JAW PARALLEL GRIPPERS

## SERIES GP400 FUNCTIONAL DESCRIPTION



### SENSORS

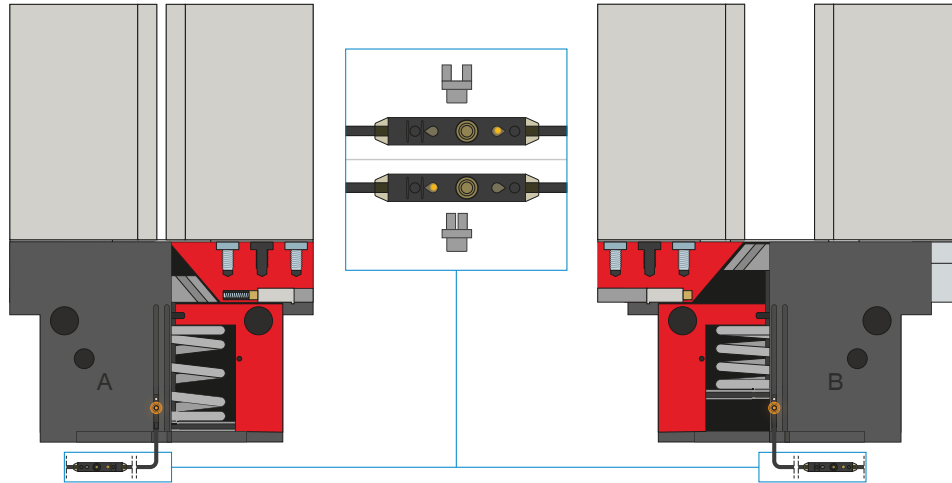

#### 2-point magnetic field sensors - MFS

With two freely programmable switching points

Using the programming unit integrated in the cable, two switch points can be freely defined for this sensor. To do so, the sensor is clamped in the C-groove, the gripper approaches position one and the position is taught in using the teach button. Afterwards, the second position is approached with the gripper and programmed. To ensure use in a wide variety of space conditions, the sensors are available in two variants. While the horizontal MFS02, with straight cable outlet, disappears into the C-groove of the gripper almost completely, the vertical MFS01 is taller, but has a cable outlet that is offset at an angle of 90°. The sensors are available in versions with 5 m cables with exposed leads and 0,3 m cable with connector.



### CONNECTIONS / OTHER

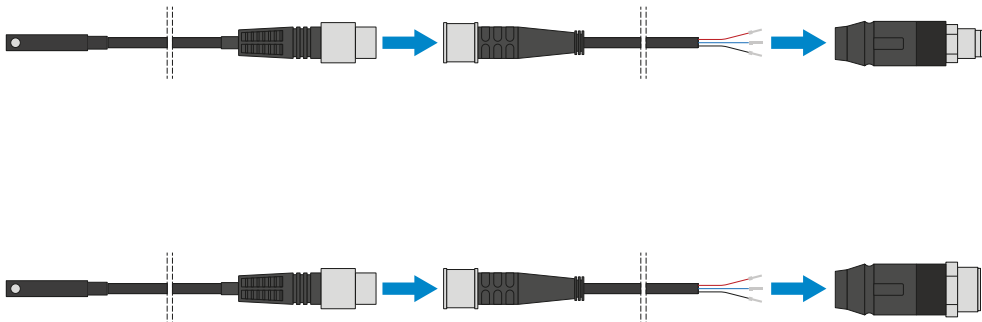

#### Plug-in connectors

For extending and fabricating the connection lines for the sensors

Cables with a length of 5 m with exposed leads are available. Depending on the specific needs, the cables can be shortened or fabricated with connectors in sizes M8 and M12.



## CONNECTIONS / OTHER

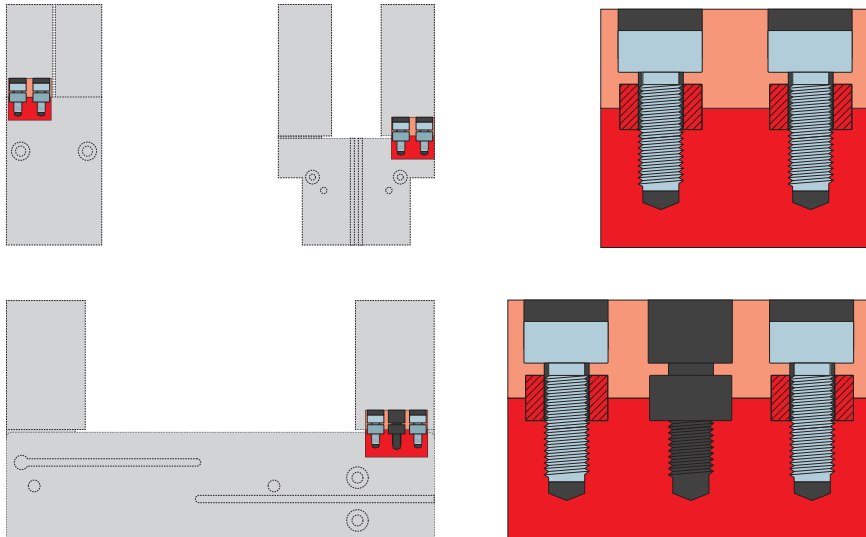

### Centering sleeves

#### For defined position measurement of the gripper fingers

The centering sleeves are inserted into the fits of the gripper jaws to define the position of the gripper fingers. The centering sleeves are comparable to a pin connection.