

# 2-JAW PARALLEL GRIPPERS WITH LONG STROKE SERIES GPH8000

## ▶ PRODUCT ADVANTAGES



### “The powerful”

#### ▶ Extremely long and heavy gripper fingers possible

Despite their flat structural design, one of the features of the gripper fingers is that there are virtually no limitations where it comes to loading the machine with engine blocks or rims.







#### ▶ Synchronous, asynchronous and securing the workpiece

Select between synchronous or asynchronous gripper finger movement and increase process safety by using the integrated clamping element to secure the workpiece in the event of a drop in pressure

#### ▶ Dirt protection

Using the scrapers on the guides, you can reliably use the gripper even under the harshest conditions

## ▶ SERIES CHARACTERISTICS

Installation size	Version		
GPH8XXX	N-00	CL-00	CL-30
 Gripper jaws are synchronized	●	●	
 Position maintenance by means of clamping element		●	●
 5 million maintenance-free cycles (max.)	●	●	●
 Inductive sensor	●	●	●
 Protected against corrosion	●	●	●
 IP 54	●	●	●



## ► BENEFITS IN DETAIL

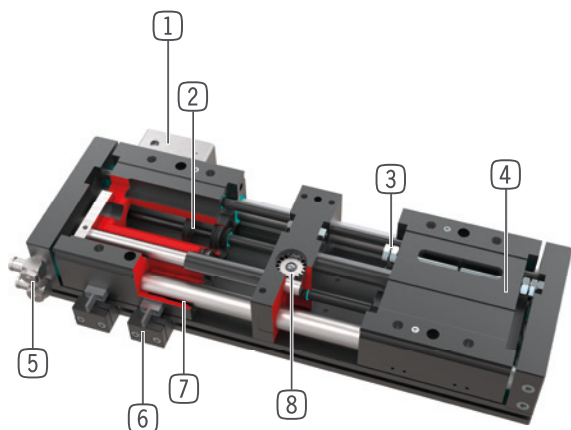

- ① **Clamping element**
  - Workpiece secured in the event of a drop in pressure
- ② **Drive**
  - two double-acting pneumatic cylinders
- ③ **Stroke adjustment**
  - possible on both sides via stroke adjustment screws
- ④ **Gripper jaw**
  - individual gripper finger mounting
- ⑤ **Energy supply**
  - possible from several sides
  - CAUTION: always operate long stroke gripper with supplied exhaust air flow control valve (speed regulation)
- ⑥ **Mounting block**
  - mounting for inductive proximity switch
- ⑦ **Roller slide**
  - sealed round guide for harsh environmental conditions
  - Maintenance-free plain bearing bushes
- ⑧ **Synchronization**
  - By means of gear and rack
  - Encapsulated and protected against dirt
  - Also available as an asynchronous variant

## ► TECHNICAL DATA

Installation size	Stroke per jaw [mm]	Gripping force [N]	Weight [kg]	IP class
GPH8200	60 - 100	900	5,7 - 8,3	IP54
GPH8300	62,5 - 150	2000	15,2 - 21,4	IP54
GPH8400	80 - 220	3300	33,9 - 51	IP54

## ► FURTHER INFORMATION IS AVAILABLE ONLINE



All information just a click away at: [www.zimmer-group.com](http://www.zimmer-group.com). Find data, illustrations, 3D models and operating instructions for your installation size using the order number for your desired product. Quick, clear and always up-to-date.

# 2-JAW PARALLEL GRIPPERS WITH LONG STROKE

## INSTALLATION SIZE GPH82060

### ▶ PRODUCT SPECIFICATIONS

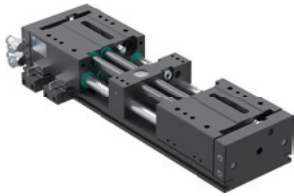

#### ▶ Gripping force diagram

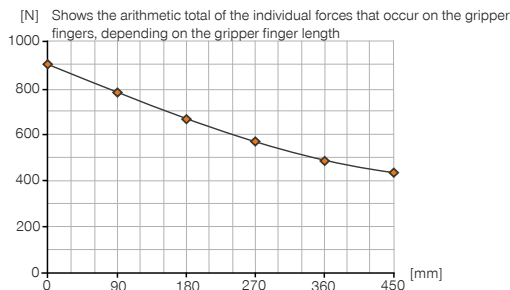

#### ▶ Forces and moments

Displays static forces and moments that can also have an effect, besides the gripping force.

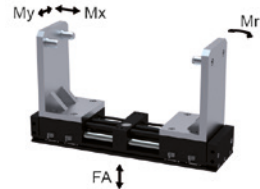

Mr [Nm]	400
Mx [Nm]	400
My [Nm]	400
Fa [N]	8000

### ▶ INCLUDED IN DELIVERY (SYNCHRONOUS / -00-A)



2 [piece]  
Mounting block  
**ANS000002**



2 [piece]  
Centering Disc  
**DST41000**



2 [piece]  
Flow Control Valves - with Swivel joint  
**DRV1-8X6**

### ▶ INCLUDED IN DELIVERY (ASYNCHRONOUS / -30-A)



4 [piece]  
Mounting block  
**ANS000002**



2 [piece]  
Centering Disc  
**DST41000**



4 [piece]  
Flow Control Valves - with Swivel joint  
**DRV1-8X6**

### ▶ RECOMMENDED ACCESSORIES



#### SENSORS



**NJ8-E2**  
Inductive proximity switch - Cable 5 m



**NJ8-E2S**  
Inductive proximity switch - Connector M8



#### CONNECTIONS / OTHER



**KAW500**  
Plug-in connector Angled Cable 5m - Socket M8 (female)



**S8-G-3**  
Plug-in connector customizable Straight - Connector M8



**S12-G-3**  
Plug-in connector customizable Straight - Connector M12



#### CONNECTIONS / OTHER



**KAG500**  
Plug-in connector Straight Cable 5m - Socket M8 (female)



**PHE10X10NHDD-A**  
Industrial shock absorbers PowerStop



# 2-JAW PARALLEL GRIPPERS WITH LONG STROKE SERIES GPH8000 FUNCTIONAL DESCRIPTION



## ENERGY SUPPLY

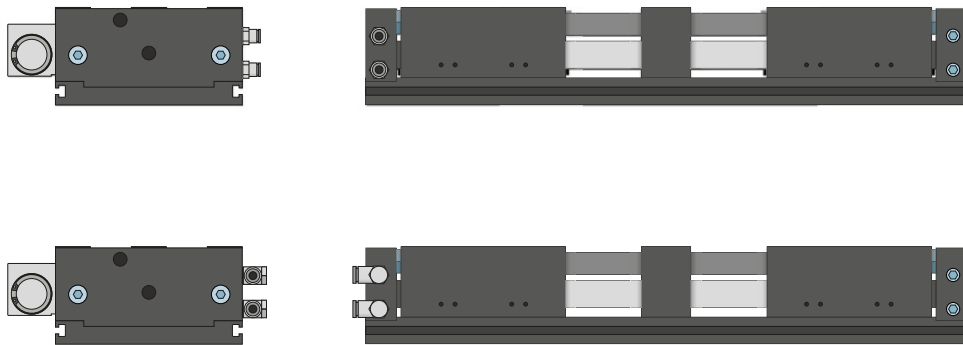

### Pneumatic threaded connections

Available in straight and angled design. Can be chosen freely depending on the space conditions or installation situation.



## SENSORS

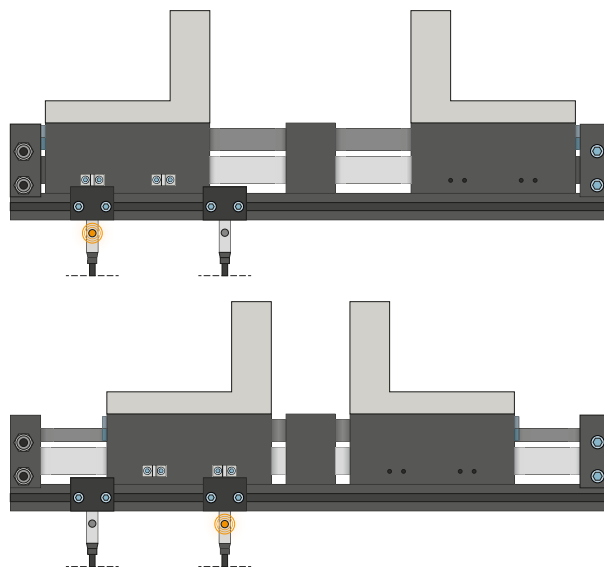

### Inductive sensors – NJ

The mounting block is aligned to the cam switch, and the sensor is guided into the mounting block until the required switching distance to the cam switch is reached. Fine adjustment can be made by moving the mounting block again. The sensors are available in versions with 5 m cables with exposed leads and 0,3 m cable with connector, as well as with direct plug orientation.



## CONNECTIONS / OTHER



### Plug-in connectors

#### For extending and fabricating the connection lines for the sensors

Cables with a length of 5 m with exposed leads are available. Depending on the specific needs, the cables can be shortened or fabricated with connectors in sizes M8 and M12.

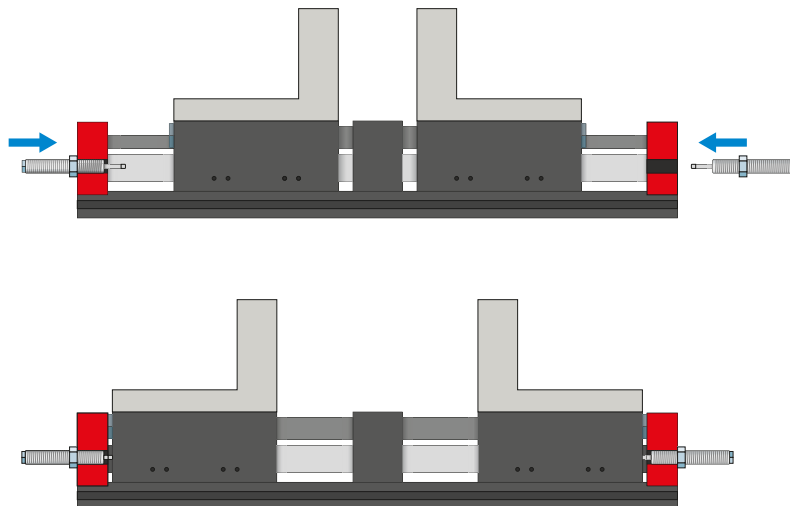

### PowerStop shock absorber

#### For soft absorption of kinetic energy

The shock absorbers are used primarily in fast, unthrottled jaw movements. They are equally suitable for long gripper fingers, high jaw mass and for cycle time optimization. The energy is absorbed by means of a hydraulic industrial shock absorber.

# 2-JAW PARALLEL GRIPPERS WITH LONG STROKE SERIES GPH8000 FUNCTIONAL DESCRIPTION



## CONNECTIONS / OTHER

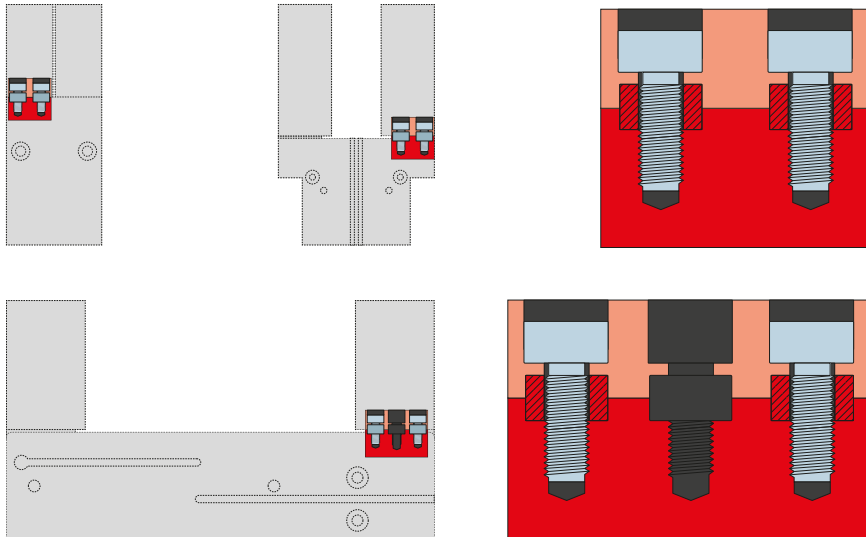

### Centering sleeves

#### For defined position measurement of the gripper fingers

The centering sleeves are inserted into the fits of the gripper jaws to define the position of the gripper fingers. The centering sleeves are comparable to a pin connection.