

# 球形连接

## KG 系列

### ▶ 产品优点



#### ▶ 可锁定位移位置

使您的应用灵活起来, 根据您的工件来定制抓取且能锁定工件位移位置来确保生产可靠性

#### ▶ 大定位法兰

大连接面简化了您的设计并且可牢固连接其他部件

#### ▶ 钢材质设计

高保持力和高扭矩确保您使用的灵活性和最高动态化

### ▶ 面向您具体应用的合适产品



#### ▶ 我们的产品钟爱挑战!

无论哪种极端条件, 无论置身世界何方, 我们久经实践考验的零部件和系统都能实现无尽可能。

欢迎为您的应用挑选合适的产品:

[www.zimmer-group.com](http://www.zimmer-group.com)



## 产品规格



## 力和力矩

显示可作用于球关节的静力和扭矩

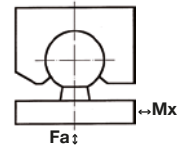

## 技术数据

订购编号	KG40	KG40ST	KG60	KG60ST	KG80	KG80ST
摆动角度 [°]	30	30	30	30	30	30
Mx [Nm]	18	18	55	55	124	124
Fa [N]	7500	18000	15000	45000	28000	70000
重量 [kg]	0.098	0.27	0.33	0.91	0.8	2.2

KG40  
KG40ST

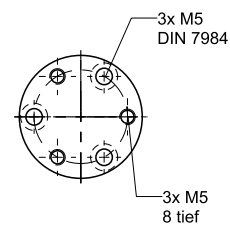
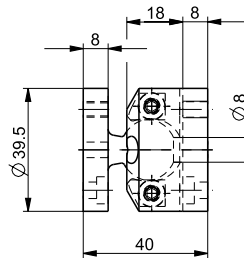
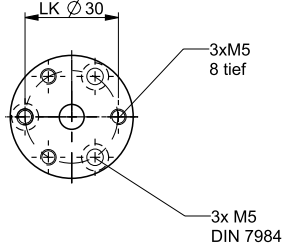

KG60  
KG60ST

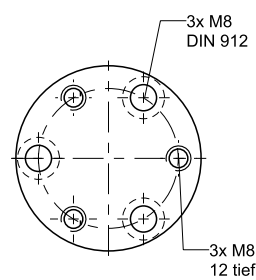
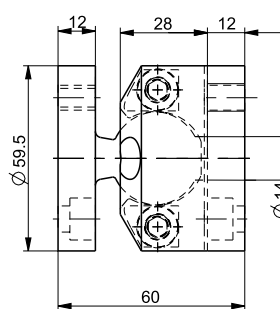
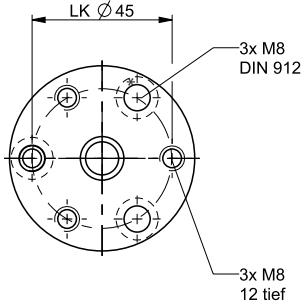

KG80  
KG80ST

