

ROTARY CYLINDERS

SERIES PRN

▶ PRODUCT ADVANTAGES

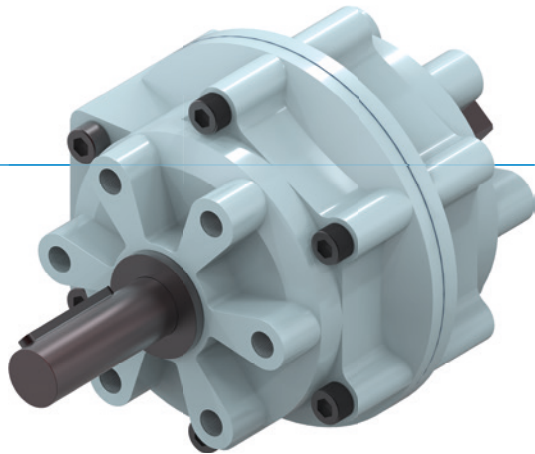

“The economical”

▶ Concentration on the essentials

The most economic type of swivelling reduces your production costs







▶ Dampened end position

Using the hydraulic brake allows you to move up to the end positions gently, increasing the process reliability and durability of your application

▶ Forged drive shaft

This shaft is not only robust, but can be individually adjusted

▶ SERIES CHARACTERISTICS

Installation size		Version				
PRNXXX		-90	-100	-180	-270	-280
 1.5 Mio 1.5 Mio	1.5 million maintenance-free cycles (max.)	•	•	•	•	•
 IP 54	IP54	•	•	•	•	•
 +	Inductive sensor	•	•	•	•	•
	Positionability - 2 positions	•	•	•	•	•
	Rotation angle 90°	•				
	Rotation angle 180°			•		
	Rotation angle 270°				•	



▶ STARTING ANGLE



- ① Starting angle
- ② Swivel angle



Installation size

PRN1	PRN20
PRN3	PRN30
PRN10	PRN50
	PRN150
	PRN300
	PRN800

▶ TECHNICAL DATA

Installation size	Swivel angle [°]	Torque [Nm]	Weight [kg]	IP class
PRN1	90 - 270	0,15	0,04	IP54
PRN3	90 - 270	0,38	0,07	IP54
PRN10	90 - 270	1,2	0,14	IP54
PRN20	90 - 270	2,1	0,25	IP54
PRN30	90 - 270	4,1	0,5	IP54
PRN50	90 - 270	5,9 - 12,8	0,75 - 0,8	IP54
PRN150	90 - 270	18 - 41,5	1,6 - 1,9	IP54
PRN300	90 - 270	34,5 - 83	3,6 - 4,1	IP54
PRN800	90 - 270	123 - 247	12 - 13	IP54

▶ FURTHER INFORMATION IS AVAILABLE ONLINE



All information just a click away at: www.zimmer-group.com. Find data, illustrations, 3D models and operating instructions for your installation size using the order number for your desired product. Quick, clear and always up-to-date.

ROTARY CYLINDERS

INSTALLATION SIZE PRN20

▶ PRODUCT SPECIFICATIONS



▶ Moment of inertia

[kg cm²] Shows the expected swivel time vs the calculated moment of inertia

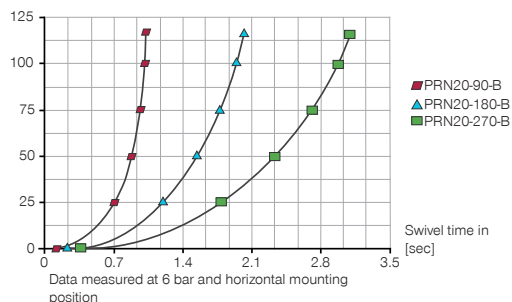

▶ Forces and moments

Shows the maximum static shaft load.

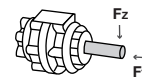

FY [N]	25
FZ [N]	300

▶ RECOMMENDED ACCESSORIES



ENERGY SUPPLY



GVM5
Straight Fittings - Quick Connect Style



DRVM5X4
Flow Control Valves - with Swivel joint



DSV1-8
Pressure safety valve



DSV1-8E
Pressure safety valve with quick exhaust



CONNECTIONS / OTHER



F20-P
Flange



F20-LB
Angle flange



DB20
Rotation limiter

▶ RECOMMENDED ACCESSORY ROTATION LIMITER



AI-M8X1-38
Stop Stroke Adjustment Screws



NJ12-E2S
Inductive proximity switch - Connector M8



KAW500
Plug-in connector Angled Cable 5m - Socket M8 (female)

Order no.	► Technical data		
	PRN20-90-B	PRN20-180-B	PRN20-270-B
Swivel angle [°]	90	180	270
Tolerance swivel angle [°]	0° / +4°	0° / +4°	0° / +4°
Starting Angle [°]	90	90	45
Torque [Nm]	2.1	2.1	2.1
Swivel time [s]	0.14	0.25	0.34
Operating pressure min. [bar]	2	2	2
Operating pressure max. [bar]	10	10	10
Nominal operating pressure [bar]	6	6	6
Operating temperature min. [°C]	-5	-5	-5
Operating temperature max. [°C]	+80	+80	+80
Air volume per cycle [cm ³]	34	34	34
Protection to IEC 60529	IP54	IP54	IP54
Weight [kg]	0.3	0.25	0.3

- ① Energy supply
- ② Fixing Rotor
- Ⓐ Air connection (0°-90°/180°/270°)
- Ⓑ Air connection (90°/180°/270°-0°)
- Ⓐ Alternate air connection 0°-90°/180°/270°
- Ⓑ Alternate air connection 90°/180°/270°-0°

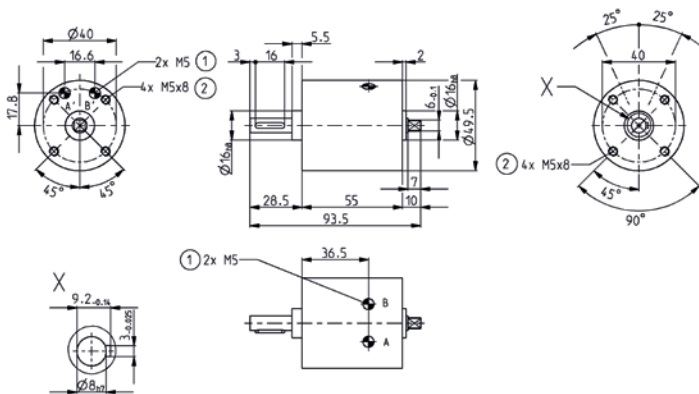

ROTARY CYLINDERS

ACCESSORIES SERIES PRN

► OIL DAMPER FOR PNEUMATIC ROTOR



► Technical data

Order no.	CRN50	CRN150	CRN300
suitable for	PRN50	PRN150	PRN300
Brake angle [°]	11	12	14
Energy absorption per stroke max. [Nm]	3	10	20
Energy absorption per stroke max. [Nm/h]	12000	43200	84000
Operating temperature min. [°C]	5	5	5
Operating temperature max. [°C]	50	50	50
Weight [g]	240	420	780

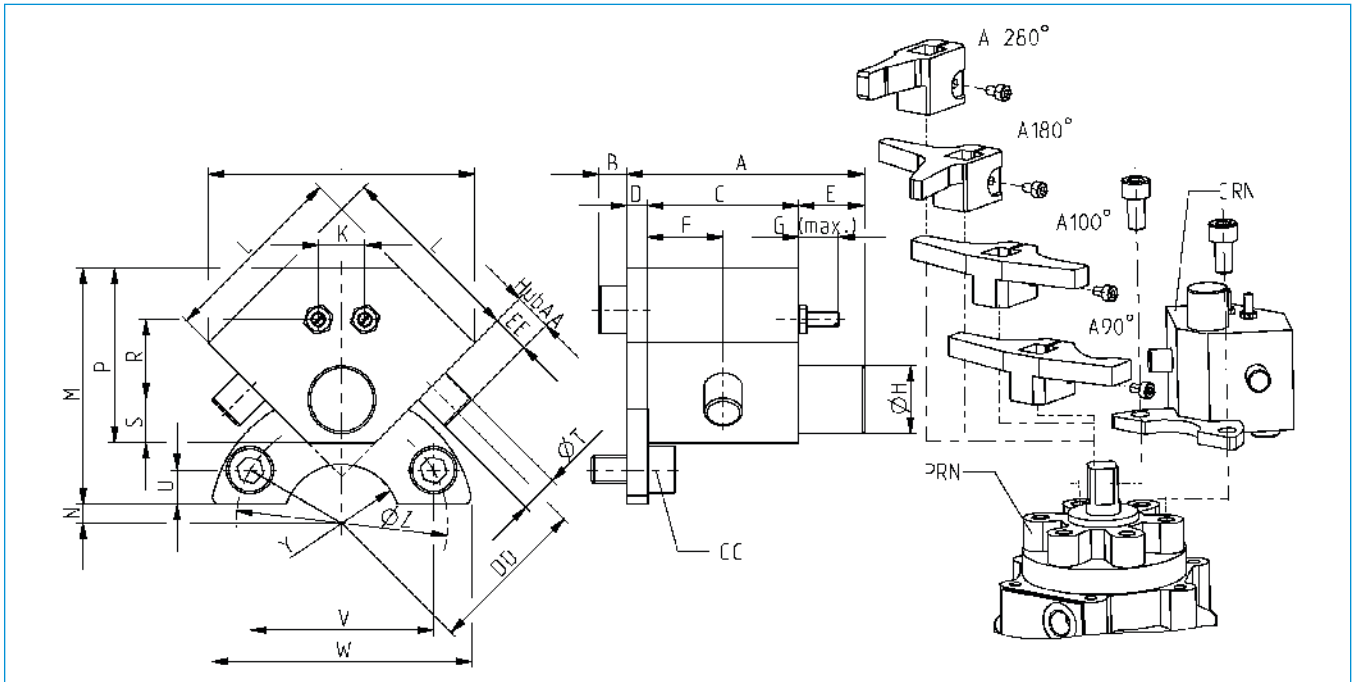

Order no.	A	B	C	D	E	F	G	H	J	K	L	M	N	P	R	S	T	U	V	W	Y	Z	AA	CC	DD	EE
	[mm]	[mm]	[mm]	[mm]	[mm]	[mm]	[mm]	[mm]	[mm]	[mm]	[mm]	[mm]	[mm]	[mm]	[mm]	[mm]	[mm]	[mm]	[mm]	[mm]	[mm]	[mm]	[mm]	[mm]	[mm]	[mm]
CRN50	50.6	6.0	3.2	4.5	14	16	8.5	∅14,4	56.6	9.9	40	50	4.0	37	17.0	9.2	∅8	7.2	39.0	56	R12,5	∅45	6.5	M6x1x12	34	8
CRN150	56.5	7.2	3.6	4.5	16	18	8.5	∅18,4	70.7	11.3	50	62	9.5	49	25.5	11.4	∅10	8.0	60.6	80	R15,0	∅70	10.0	M8x1,25x16	46	12
CRN300	62.5	7.2	4.2	4.5	16	21	12.0	∅22,5	91.9	12.7	65	87	8.0	61	33.2	14.1	∅12	12.0	69.2	95	R22,5	∅80	15.0	M10x1,5x20	62	18

▶ STOP LEVER FOR OIL DAMPER



▶ STOP LEVER PRN50

▶ Technical data

Order no.	A50-90-B	A50-180-B	A50-270
Swivel angle [°]	90	180	270

▶ STOP LEVER PRN150

▶ Technical data

Order no.	A150-90-B	A150-180-B	A150-270
Swivel angle [°]	90	180	270

▶ STOP LEVER PRN300

▶ Technical data

Order no.	A300-90-B	A300-180-B	A300-270
Swivel angle [°]	90	180	270