

TOOL CHANGERS

SERIES WWR

▶ PRODUCT ADVANTAGES

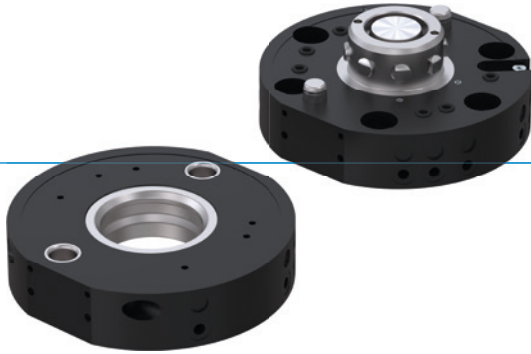

▶ **Secure hold during pressure drop**

The combination of spring loaded and a high gear ratio guarantees them a safe machine

▶ **Extremely flat design**

This structure reduces the moment load for your robot to a minimum and makes it possible to use smaller and more affordable sizes

▶ **Inexhaustible variety of media transfer systems**

No matter which medium you would like to transmit, we will draw from our wealth of experience in implementing projects and find a solution to suit your needs!

▶ THE BEST PRODUCT FOR YOUR APPLICATION



▶ **Our products welcome the challenge!**

Extreme conditions, all over the world—our tried and tested components and systems give you endless possibilities.

Find the best product for your specific use:

www.zimmer-group.com

► BENEFITS IN DETAIL

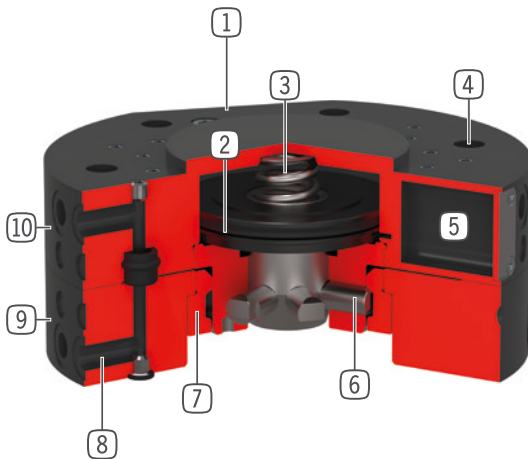

- ① **Mounting for energy element**
- ② **Drive**
- double-acting pneumatic cylinder
- ③ **Integrated spring**
- energy storage in case of drop in pressure
- ④ **Robot flange**
- partial mounting circle in accordance with EN ISO 9409-1
- ⑤ **Piston position sensing**
- via magnetic field sensor
- ⑥ **Locking bolt**
- adapted to the clamping sleeve
- ⑦ **Locking sleeve**
- high moment capacity
- ⑧ **Integrated air feed-through**
- Air / vacuum transfer
- hoseless control possible
- ⑨ **Loose part**
- for tool side assembly
- ① ⑩ **Fix part**
- For robot side assembly

► TECHNICAL DATA

Installation size	Connecting flange according EN ISO 9409-1	Pneumatic energy transfer	Electrical energy transfer
		[Quantity]	
WWR40	TK 40	4	optional
WWR50	TK 50	4	optional
WWR63	TK 63	6	optional
WWR80	TK 80	6	optional
WWR100	TK 100	6	optional
WWR125	TK 125	10	optional
WWR160	TK 160	10	optional

► FURTHER INFORMATION IS AVAILABLE ONLINE



All information just a click away at: www.zimmer-group.com. Find data, illustrations, 3D models and operating instructions for your installation size using the order number for your desired product. Quick, clear and always up-to-date.

TOOL CHANGERS

INSTALLATION SIZE WWR63

▶ PRODUCT SPECIFICATIONS



▶ Variable installation position

Shows the maximum handling weight depending on acceleration and lever arm. Does not replace the technical design.

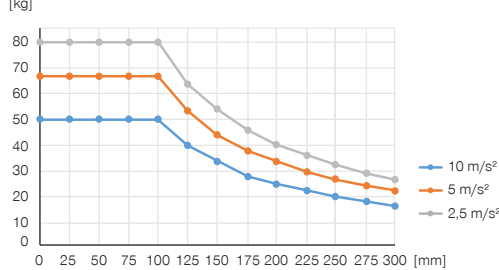

▶ Forces and moments

Shows static forces and moments which may impact on the tool changer.

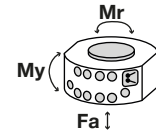

Mr [Nm]	200
My [Nm]	300
Fa [N]	7600

▶ INCLUDED IN DELIVERY



6 [piece]
O-Ring
COR0030100

▶ RECOMMENDED ACCESSORIES



ENERGY SUPPLY



GVM5
Straight Fittings - Quick Connect Style



WVM5
Angled Fittings - Quick Connect Style



SENSORS



ZUB088927
Piston position sensing



SENSORS



NJR04-E2SK
Inductive Proximity Switch Cable 0,3 m - Connector M8



CONNECTIONS / OTHER



Energy elements and accessories for tool changer



ALSR1-63-B
Storage station

▶ RECOMMENDED ACCESSORY STORAGE STATION



NJ8-E2
Inductive proximity switch - Cable 5 m



NJ8-E2S
Inductive proximity switch - Connector M8

Order no.	▶ Technical data	
	WWR63F-B	WWR63L-B
Connecting flange according EN ISO 9409-1	TK 63	TK 63
Pneumatic energy transfer [Quantity]	6	6
Flow per connector [l/min]	170	170
Electrical energy transfer	optional	optional
Self locking mechanism when locking	mechanical	mechanical
Locking stroke [mm]	1	
Repetition accuracy in Z [mm]	0.01	0.01
Repetition accuracy in X, Y [mm]	0.02	0.02
Joining force [N]	110	
Release force [N]	60	
Offset at coupling max. in X,Y [mm]	1.65	1.65
Operating pressure [bar]	4 ... 10	4 ... 10
Nominal operating pressure [bar]	6	6
Operating temperature [°C]	5 ... +80	5 ... +80
Air volume per cycle [cm ³]	9	
Moment of inertia [kgcm ²]	2.3	2.2
Weight [kg]	0.37	0.3

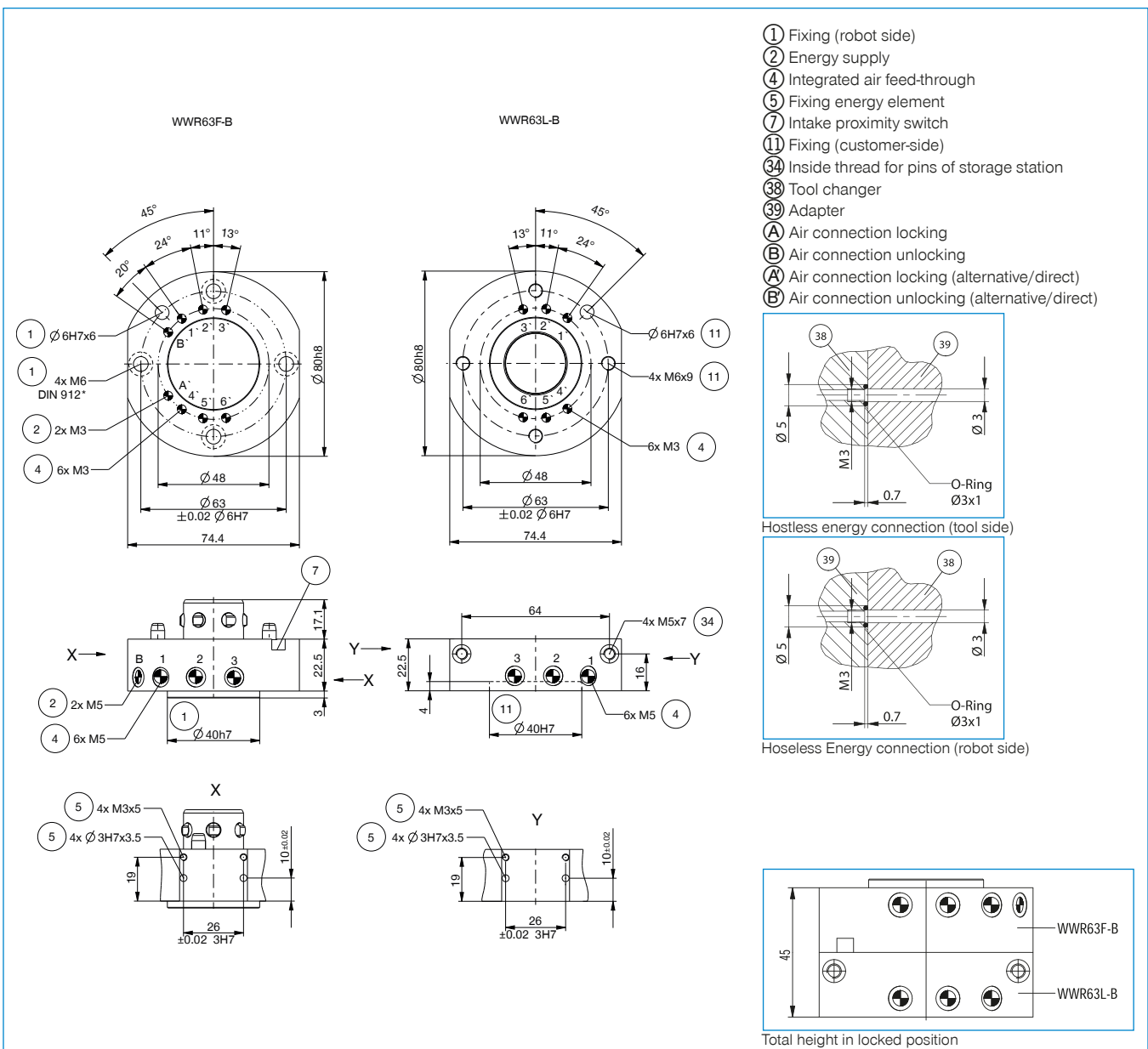

ENERGY ELEMENTS FOR TOOL CHANGER SIZES WWR63 / WWR80

▶ CONNECTION DIAGRAM

