

# PISTON POSITION SENSING

## ZUB109824

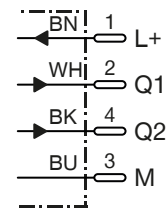

Connection diagram

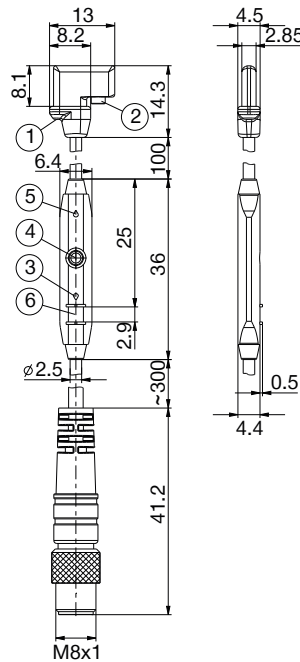
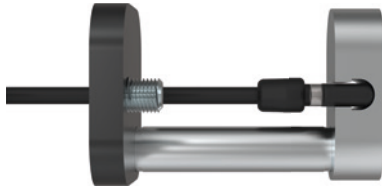

PIN assignment

- ① Center of sensor element
- ② Fixing screw
- ③ Display LED
- ④ Teach-in button
- ⑤ Display LED
- ⑥ Ribs for cable ties

Order no.	ZUB109824
<b>General data</b>	
Compatible with installation size	XYR1160-B
Cylinder design	C-slot
Switching output	PNP
Switching frequency [Hz]	7000
Switching function	Normally open (NO)
Programmable switching points	2
Electrical version	DC 4-wire
Protection to IEC 60529	IP67
Certification	CE
<b>Electrical / Mechanical data</b>	
Supply voltage min. [V DC]	12
Supply voltage max. [V DC]	30
Current consumption [mA]	≤15
Voltage drop [V]	≤2.2
Continuous current [mA]	≤100
Detection zone [mm]	0 ... 20
Hysteresis typ. [mT]	0.795
Reproducibility [mT]	≤0.1
Protected against polarity reversal	Yes
Short-circuit-proof	Yes
Power-up pulse protection	Yes
Operating temperature min. [°C]	-20
Operating temperature max. [°C]	+75
Shock and vibration resistance	30 g, 11 ms / 10 ... 55 Hz, 1 mm
Housing Material	Plastics
Connection type	Cable/Connector
Fixing thread	M8
Installation type	Cable outlet radial
Cable length [m]	0.3
Nr. of wires x diameter [mm <sup>2</sup> ]	4x0.08
Cable sheath material	PUR
Bending radius for fixed routing, min.	3x∅
Bending radius when using a drag chain, min.	5x∅