



Artikel mit gleicher Buchstabenkennzeichnung müssen aus Toleranzgründen zusammen bestellt werden.

Due to tolerance reasons, articles with the same letter marking must be ordered together.

Ersatzteilstückliste Parts list		WER3000FSI18-21-A	
Pos. Item	Menge Quantity	Artikel-Nr. Article-No.	
10	1	ZWER127089	
20	1	009854	
30	1	127087	
40	1	SPL000273	
50	2	C0912025044D	
60	12	C0912025084D	
70	2	C091505069	
80	1	C091505089	
90	19	CELE00390	
100	2	CELE00988	
110	1	CLTG00460	
120	19	CSFT00002	
130	1	CSTE00405	
140	1	CTYP00117	
150	1	DDOC00214	

Erstellungsdatum Creation date	12.08.21	Aenderungsdatum Modification date	02.05.24
-----------------------------------	----------	--------------------------------------	----------

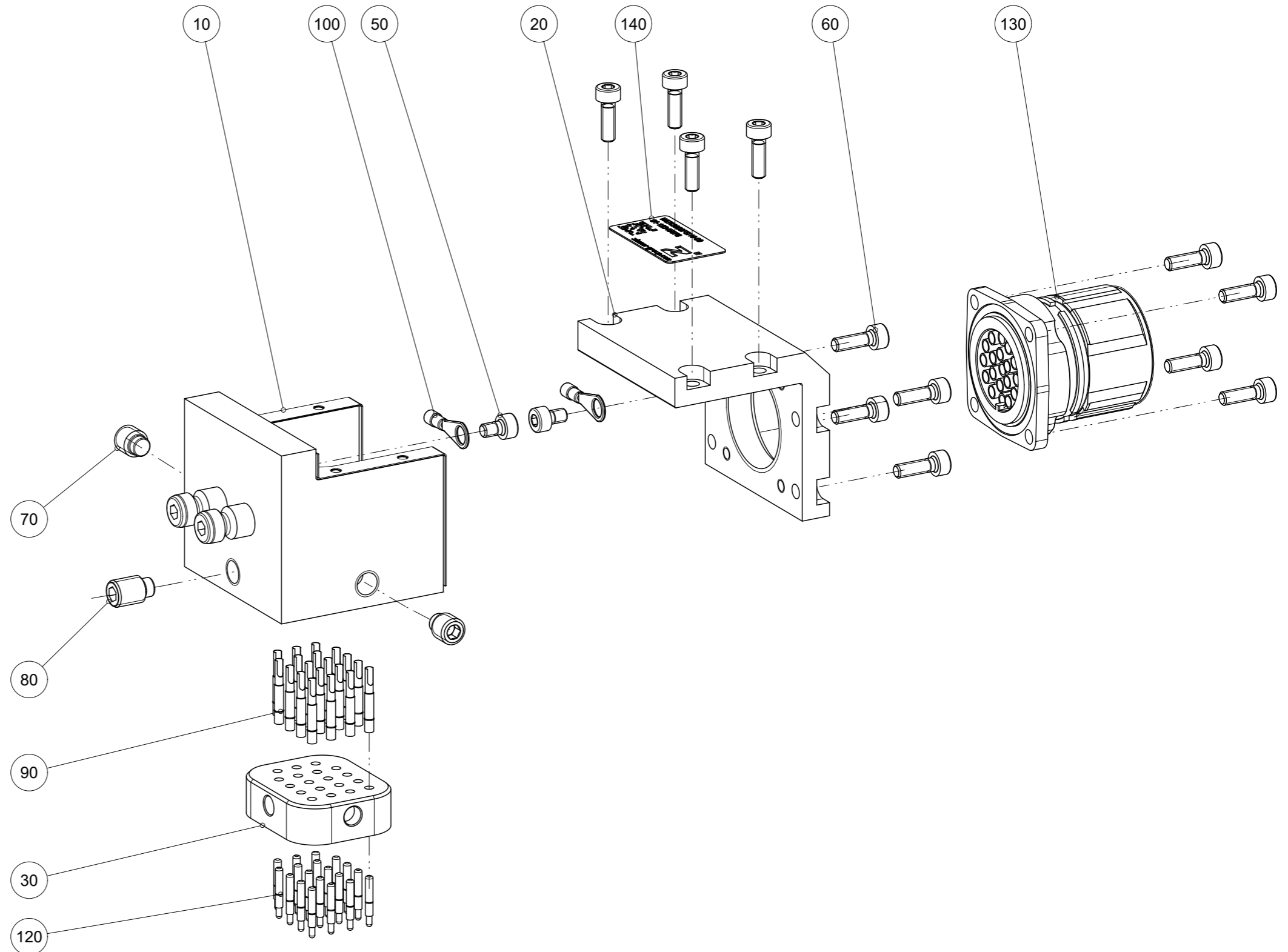

Zimmer Group  
Im Salmenkopf 5  
D-77866 Rheinau

[www.zimmer-group.de](http://www.zimmer-group.de)

T +49 7844 9138-0  
F +49 7844 9138-80

[info@zimmer-group.de](mailto:info@zimmer-group.de)